



# CLOUDLINE

## AIR FILTRATION SYSTEM

AC INFINITY



## WELCOME

Thank you for choosing AC Infinity. We are committed to product quality and friendly customer service. If you have any questions or suggestions, please don't hesitate to [contact](#) us. Visit [www.acinfinity.com](http://www.acinfinity.com) and click contact for our contact information.

### EMAIL

[support@acinfinity.com](mailto:support@acinfinity.com)

### WEB

[www.acinfinity.com](http://www.acinfinity.com)

### LOCATION

Los Angeles, CA

## MANUAL CODE AFK2403X1

### PRODUCT

Air Filtration System 4", S-Series

Air Filtration System 6", S-Series

Air Filtration System 8", S-Series

Air Filtration System 4", T-Series

Air Filtration System 6", T-Series

Air Filtration System 8", T-Series

### MODEL

AC-FKS4

AC-FKS6

AC-FKS8

AC-FKT4

AC-FKT6

AC-FKT8

### UPC-A

819137022065

819137021891

819137022072

819137022911

819137022928

819137022980

# MANUAL INDEX

Manual Index .....	Page 5
Product Warning .....	Page 6
Interference from MH and HPS Lights .....	Page 7
Key Features .....	Page 8
Product Contents .....	Page 9
Installation: Mounting .....	Page 11
Installation: Hanging .....	Page 16
Installation: Motor Cap Orientation .....	Page 24
Installation: Configuration Setup .....	Page 25
Powering and Setup .....	Page 28
Controller Mounting .....	Page 31
UIS™ Platform .....	Page 36
Compatibility .....	Page 37
Adding More Fans .....	Page 39
Adding More Devices .....	Page 40
Cleaning .....	Page 42
Programming .....	Page 45
Download the App .....	Page 47
Add a Device .....	Page 48
FAQ .....	Page 55
Other AC Infinity Products .....	Page 58
Warranty .....	Page 59

# PRODUCT WARNING



TO REDUCE THE RISK OF FIRE, ELECTRIC SHOCK, OR INJURY TO PERSONS, OBSERVE THE FOLLOWING:

1. Ensure your power source conforms to the electrical requirements of this product.
2. Check your local code restrictions for additional safety measures that may be needed for a proper code compliant installation.
3. Read all instructions before installing and using this product.
4. If you are unfamiliar or have doubts about performing this product's installation, seek the services of a qualified, trained, and licensed professional. Inappropriate installation will void this product's warranty.
5. Do not attempt to hardwire this product. Performing any retrofitting actions may result in personal injury and/or electrical damage, and will void this product's warranty.
6. This product must not be used in potentially hazardous locations such as flammable, explosive, chemical-laden, or wet atmospheres.
7. Ducted products must always be vented to outdoor areas.
8. Do not cover power cords with rugs or other fabric materials.
9. This product pairs with those that has rotating parts. Safety precautions should be exercised during the installation, operation, and maintenance of this product.
10. Do not insert or allow fingers or foreign objects to enter any ventilation or exhaust openings as it may cause electric shock, fire, or damage to this product. Do not block or tamper with this product in any manner while it is in operation.
11. Do not depend on the on/off programming as the sole means of shutting power from this product. Unplug the power cord before installing, servicing, or moving this product.
12. Do not operate this product while its cord is damaged, or if it malfunctions, has been dropped, or is damaged in any manner.

# INTERFERENCE from MH and HPS LIGHTS

Certain grow light models with HID\* ballasts that do not use electromagnetic shielding will create an area of radio frequency interference (RFI). This can distort nearby frequency-sensitive components like internet lines and climate sensors. RFI can be emitted from the ballast's cords or the ballast itself.

Follow these steps to ensure proper functionality and to prevent radio frequency interference from affecting your sensor probe:

## TIP 1

Keep the probe cord far away from your ballast's cords to ensure the controller properly detects climate conditions.

You may also wrap the probe cord and create a cone around the sensor head with aluminum foil tape.

## TIP 2

Do NOT plug your grow light and inline fan into the same duplex outlet. Plug your grow light and inline fan into separate power strips and electrical sockets.

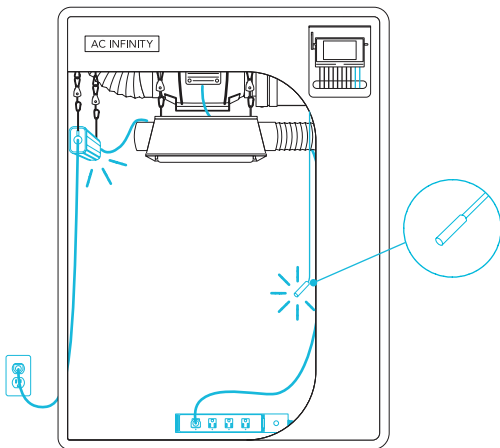

\*MH, HPS, CMH, or CHPS

# KEY FEATURES

## DUAL BALL BEARINGS

The motor contains ball bearings with a 67,000 hour lifespan. Enables the fan to be mounted in any orientation.

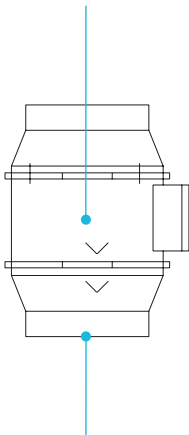

## IP54 PROTECTION

The inline duct fan is sealed to Ingress Protection 54 standards, rated with high resistance to liquids and dust.

## ACTIVATED CARBON

Features RC412 1200+ IAV Australian charcoal with high adsorption rate to completely block odor and scrub the air.

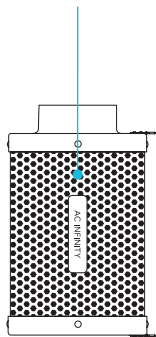

## FLEXIBLE DUCTING

The outer layer is made of dual PVC thermoplastic that protects the aluminum from cuts and tears.

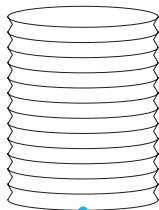

## POWERED BY AI

Sets environmental triggers and time-based controls while refining its own programming to maintain ideal conditions.

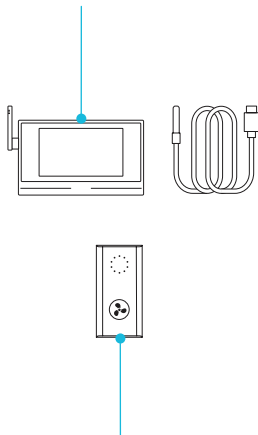

## SPEED CONTROLLER

Single button controller with circular readout display that enables fan speed control in ten speeds.



# PRODUCT CONTENTS

## CLOUDLINE S-Series



SPEED  
CONTROLLER  
(x1)



WOOD SCREWS  
(WALL HANG)  
(x1)



CONTROLLER  
PLATE BOLTS  
(x2)

## CLOUDLINE T-Series



CONTROLLER AI+  
CENTRAL HUB  
(x1)



SENSOR  
PROBE  
(x1)



POWER  
ADAPTER  
(x1)



WOOD SCREWS  
(WALL MOUNT)  
(x2)



CONTROLLER  
PLATE BOLTS  
(x2)



CABLE  
DOCK  
(x1)

## FAN UNIT

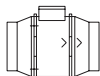

DUCT FAN  
SYSTEM  
(x1)



WIRE  
MOUNT  
(x6)



ADHESIVE  
WIRE MOUNT  
(x1)



HOOK AND  
LOOP TIES  
(x6)



WALL  
ANCHOR  
(x4)



DUCT FAN  
SCREW SET  
(x4)



UIS M-M  
CORD, 10 FT.  
(x1)



ROPE  
CLIP  
(x2)

## CARBON FILTER AND DUCTING

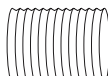

FLEXIBLE  
DUCTING  
(x1)



DUCT  
CLAMP  
(x2)

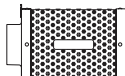

CARBON  
FILTER  
(x1)



PREFILTER  
CLOTH  
(x2)



HANGING  
STRAPS  
(x2)



ROPE  
CLIP  
(x2)

# PRODUCT CONTENTS

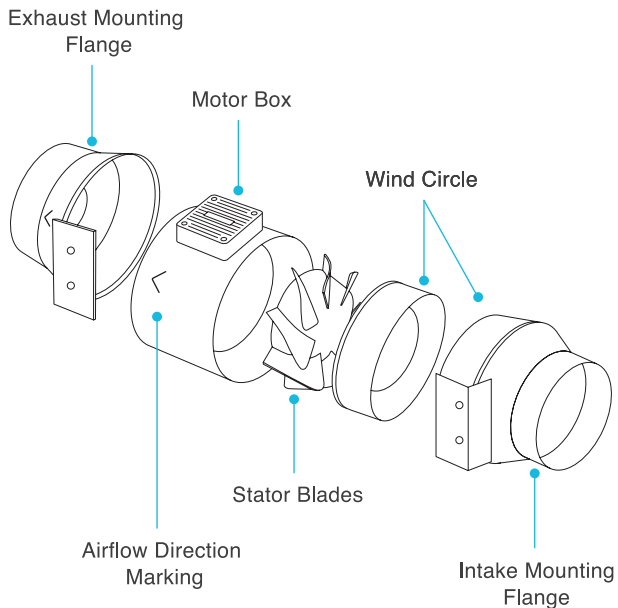

# INSTALLATION

## MOUNTING

### STEP 1

Unscrew and loosen the metal rings using a Phillips screwdriver and pliers.

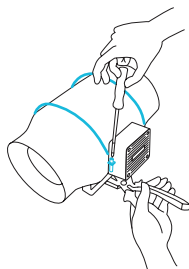

---

### STEP 2

Remove the motor box from the flange bracket.

Remove the wind circle between the motor box and the intake flange.

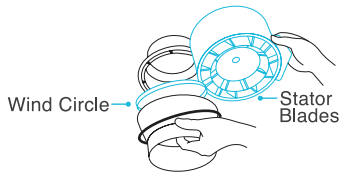
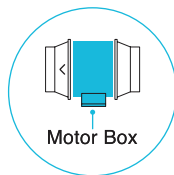

# INSTALLATION

## MOUNTING

### STEP 3

Use the flange bracket to set your desired fan position. Mark the four mounting holes.

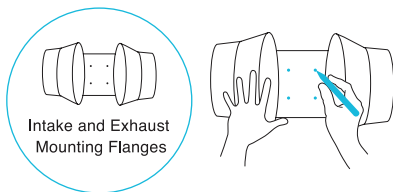

---

### STEP 4

Drill four holes into the marked locations. Make sure your mounting area is structurally sound and free from obstruction.

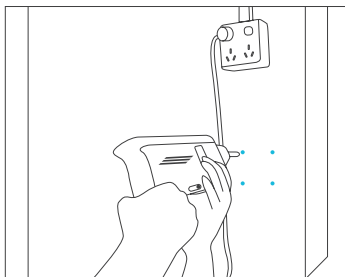

# INSTALLATION

## MOUNTING

### STEP 5

If you are mounting onto anything other than a wood support or stud, insert the included four wall anchors into the drilled mounting holes.

You may need to use a hammer to secure them through the holes.

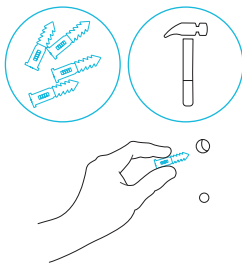

---

### STEP 6

Align the flange bracket's holes with the wall anchors. Screw in four wood screws with a screwdriver or drill to secure the flange bracket.

Make sure its airflow arrow is pointing in your desired direction.

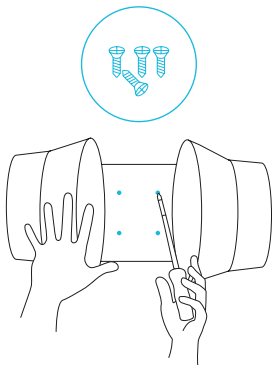

# INSTALLATION

## MOUNTING

### STEP 7

Place the wind circle back into the intake flange and reposition the metal clamps over the flanges if applicable.

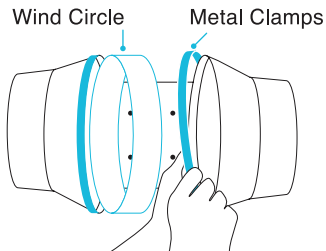

### STEP 8

Slide the motor box back into the flange bracket, making sure its airflow arrow is pointing in the same direction as the flange bracket's arrow.

Tighten the metal clamps using a Phillips screwdriver and pliers to secure the motor box.

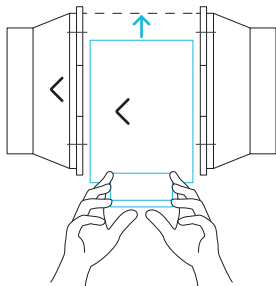

# INSTALLATION

## MOUNTING

### STEP 9

If installing ducting, use the included duct clamps to secure it to either end of the duct fan, making sure there is a tight seal.

Tighten the duct clamps using a flathead screwdriver.

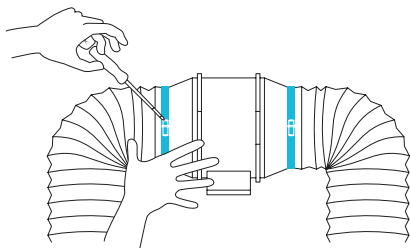

# INSTALLATION

## FAN HANGING - STRAPS

### STEP 1

Loop the strap around the bracket and a pole.

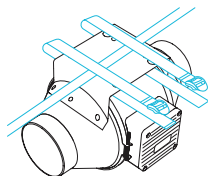

---

### STEP 2

Slip the strap through the inner ladder lock slot from the bottom.

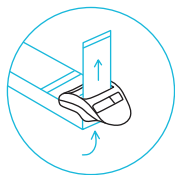



# INSTALLATION

## FAN HANGING - STRAPS

### STEP 3

Route the strap into the outer ladder lock slot from the top. Adjust the length of the completed loop as needed.

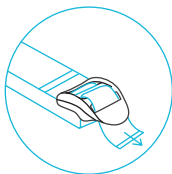
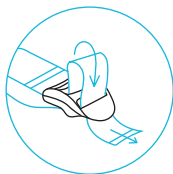

Adjust to size

---

### STEP 4

Tuck the loose end through the center gap of the ladder lock to secure the loop.

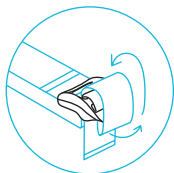

Loop through middle  
to lock in place

# INSTALLATION

## FAN HANGING - STRAPS

### STEP 5(a) - Hanging Downward

Let the fan hang by the pole once the straps are secure.

Make sure the fan's airflow arrow is pointing towards your desired direction.

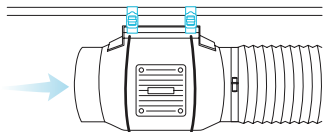

---

### STEP 5(b) - Hanging Upward

To hang the fan right-side up, loop and tighten the straps, as shown in steps 1-4, around the pole.

Hang the fan by the duct flanges to secure it.

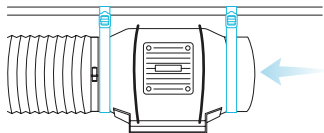

# INSTALLATION

## FILTER HANGING - STRAPS

### STEP 1

Loop the strap around a hanging pole.

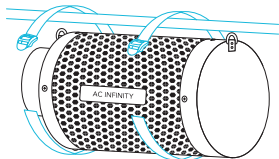

---

### STEP 2

Slip the strap through the inner ladder lock slot from the bottom.

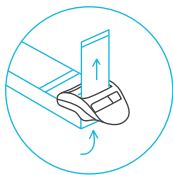

# INSTALLATION

## FILTER HANGING - STRAPS

### STEP 3

Route the strap into the outer ladder lock slot from the top. Adjust the length of the completed loop as needed.

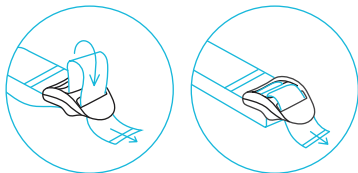

Adjust to size

---

### STEP 4

Tuck the loose ends through the center gap of the ladder lock to secure the loop.

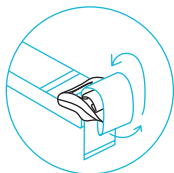

Loop through middle  
to lock in place

# INSTALLATION

## FAN HANGING - ROPE CLIPS

### HANGING UPWARD

Loop the two rope hangers around a pole and clip the carabiners onto each other. Shorten the loops as needed.

Hang the fan by the duct flanges to secure it.

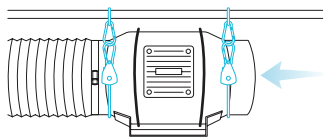

NOTE: The motor cap may be rotated to appear right side up in grow applications. See page 24 to learn how to rotate the motor cap. Rotating the motor cap will not void your warranty.

### HANGING DOWNWARD

Loop the two rope hangers around a pole and the fan's bracket.

Clip the carabiners onto each other. Shorten the loops as needed.

Make sure the fan's airflow arrow is pointing towards your desired direction.

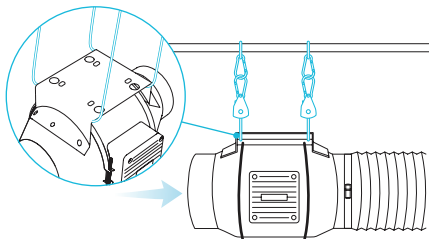

# INSTALLATION

## FILTER HANGING - ROPE CLIPS

### STEP 1

Loop the rope clip hangers around your grow tent's support beams.

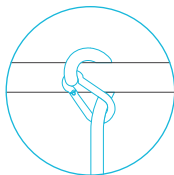

### STEP 2

Hook the carabiners into the steel hooks located on the flanges.

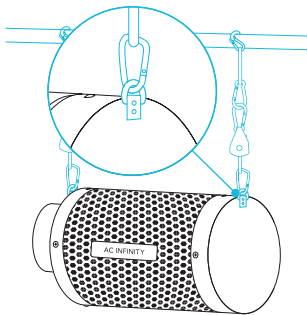

# INSTALLATION

## FILTER HANGING - ROPE CLIPS

### STEP 3

Connect your filter to your ductwork using your preferred method, as shown on page 26.

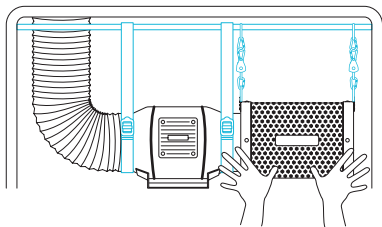

# INSTALLATION

## MOTOR CAP ORIENTATION

### STEP 1

Unscrew the motor cap using a screwdriver.

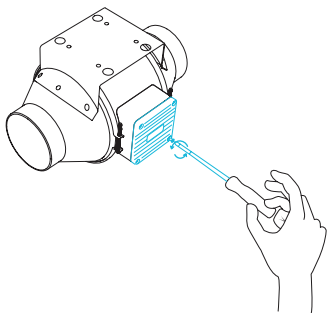

### STEP 2

Rotate the motor cap to your desired orientation. Reapply the screws.

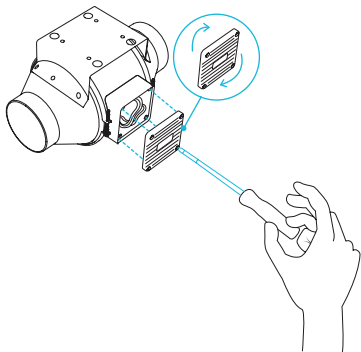

Rotating the motor cap will not void your warranty.



# INSTALLATION

## CONFIGURATION SETUP

### INTAKE AND EXHAUST

This fan can be used as either an intake fan or an exhaust fan in grow rooms and larger grow tents. To achieve optimal whole space ventilation, the intake fan or opening - if not using a fan - must be situated at a bottom corner of your grow space. The exhaust fan must be hung (shown below) or mounted at the highest opposite corner possible.

Make sure the intake fan's airflow arrow is pointing towards your grow space and the exhaust fan's arrow pointing away from your grow space.



To use this filter in intake applications, place the filter inside your grow space. Make sure the filter is connected to your inline duct fan's intake end before completing the installation.

To use this filter in exhaust applications, place the filter outside your grow space. Make sure the filter is connected to your inline duct fan's exhaust end before completing the installation.

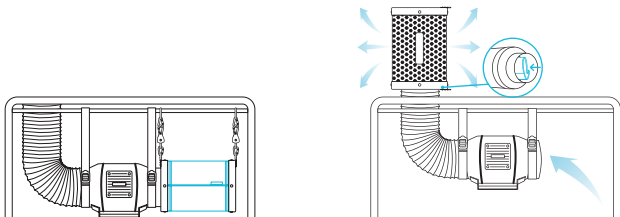

# INSTALLATION

## CONFIGURATION SETUP

### STEP 1

Connect your duct tube over your filter. Use duct clamps to secure the connection. You may also apply ducting tape before using the duct clamps for further security.

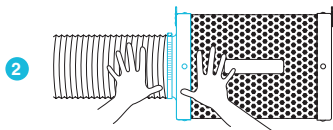
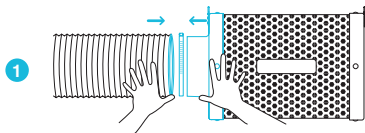

### STEP 2

You may also connect your filter directly to your inline duct fan. Use duct clamps to secure them together.

If your filter is placed in a humid space, position it at the highest point possible.

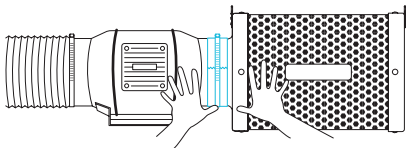
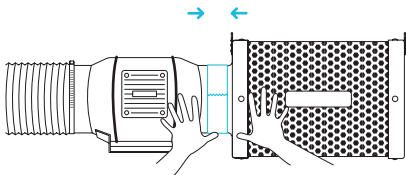

# INSTALLATION

## CONFIGURATION SETUP

### PREFILTER

When placing your filter inside your grow space, slip the cloth over your filter to block dust and other particles from passing through.

Make sure the entire metal mesh is covered by the cloth.

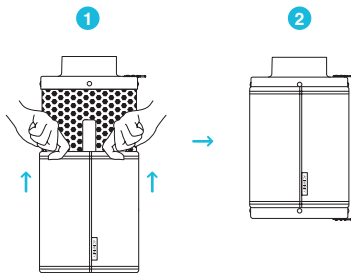

### INTERIOR HANGING

To use your filter in intake applications, place it inside your grow space.

Make sure your filter is connected to your inline duct fan's intake end before completing the installation.

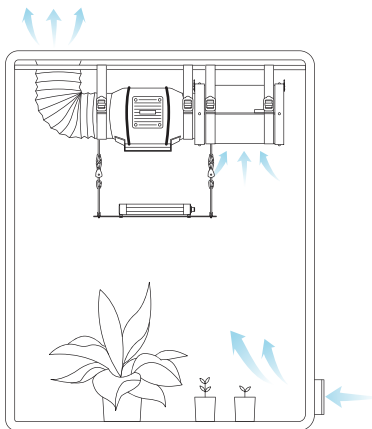

# POWERING AND SETUP

## S-SERIES

### STEP 1

Use the included UIS M-M extension cord to connect the fan to the speed controller's port at the bottom.

Plug the UIS connector with the gasket end into your fan. The gasket is specially designed to protect against liquids and dust.

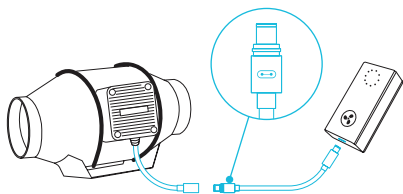

---

### STEP 2

Plug the fan's power cord into a wall outlet. The controller will receive power from the fan to operate. (EC Motor fans only)

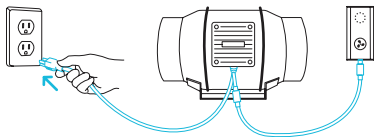

# POWERING AND SETUP

## T-SERIES

### STEP 1

Plug the sensor probe into the controller's sensor port. Set the probe near your plants in your grow tent for the most accurate reading.

Keep the probe cord away from your HID\* grow light ballast's power cord to ensure the controller properly detects climate conditions.

\*MH, HPS, CMH, or CHPS

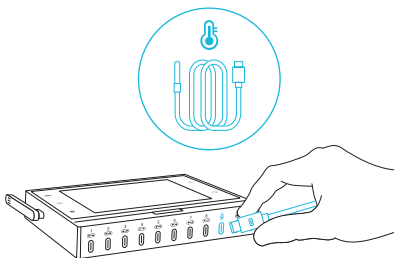

### STEP 2

Plug your the power adapter's UIS connector into the controller's power port. Plug the two-prong connector to an AC power outlet to power the controller.

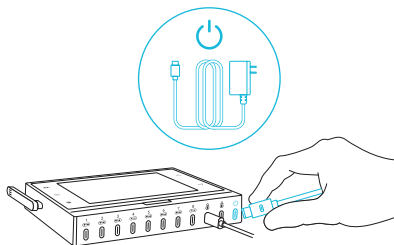

**To avoid short-circuiting, DO NOT plug your fan into the controller's power port.**

# POWERING AND SETUP

## T-SERIES

### STEP 3

Use the included UIS M-M extension cord to connect your device's UIS connector into one of the controller's ports.

Plug the UIS connector with the gasket end into your fan. The gasket is specially designed to protect against liquids and dust.

**To avoid short-circuiting, DO NOT plug your fan into the controller's power port.**

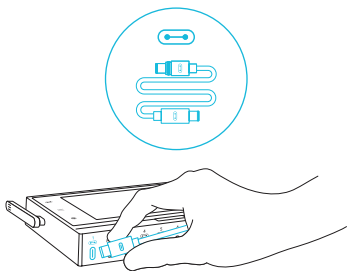

### STEP 4

You may use the included tie mounts, wood screws, and wire ties to manage the cords.

Secure the tie mounts onto a surface using the wood screws or adhesive backing. Loop the wire ties around the cords into the tie mounts.

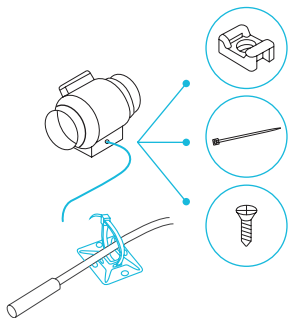

# CONTROLLER MOUNTING

## S-SERIES

### STEP 1 — WALL MOUNTING

Locate a spot free of obstruction and secure the anchor into your wall. Twist the wood screw into the anchors.

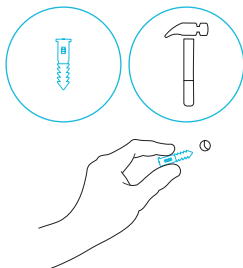

---

### STEP 2 — WALL MOUNTING

Hang the controller by the screw using the hole on the backside.

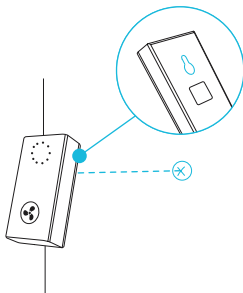

# CONTROLLER MOUNTING

## S-SERIES

### MAGNET MOUNTING

Mount the controller on a steel surface using the magnet located behind the label.

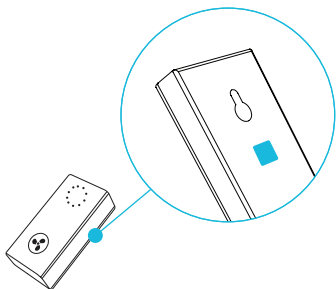

### PLATE MOUNTING\*

Screw the controller bolts into the slot or mounting holes at the upper half of the plate.

Hang the controller by the bolts using the hole on the backside.

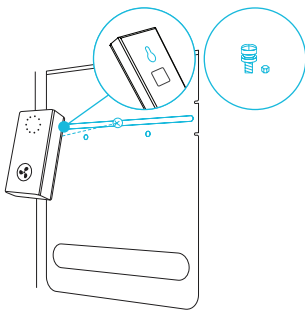

\*Controller plate not included



# CONTROLLER MOUNTING

## T-SERIES

### STEP 1 — WALL MOUNTING

Locate a spot free of obstruction and secure the anchors into your wall. Twist the wood screws into the anchors.

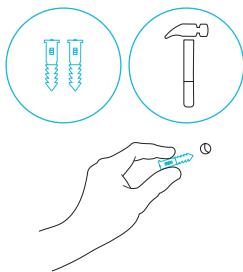

---

### STEP 2 — WALL MOUNTING

Hang the controller by the screws using the holes on the backside.

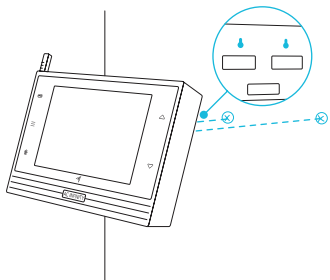

# CONTROLLER MOUNTING

## T-SERIES

### MAGNET MOUNTING

You may also mount the controller onto a steel surface using the magnet located behind the label.

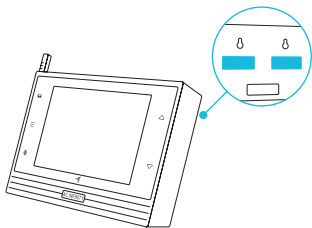

### PLATE MOUNTING\*

Screw the bolts into the slot or mounting holes at the upper half of the plate.

Hang the controller by the bolts using the holes on the backside.

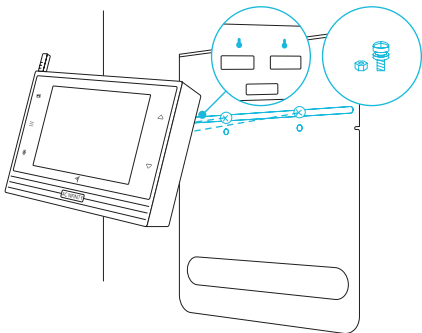

\*Controller plate not included

# CONTROLLER MOUNTING

## T-SERIES

### CORD ARRANGEMENT

Cords may be routed through the included cable dock, which has an adhesive backing for mounting on any surface.

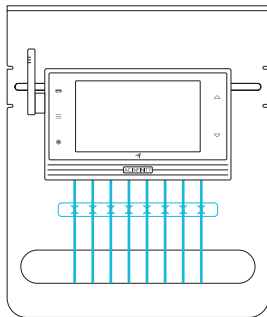

# UIS™ PLATFORM

The UIS™ platform enables you to connect a single central controller with several grow devices simultaneously. By creating this fully integrated system, you can power and program all your devices together or separately for optimized grow tent management.

Your grow system can be regulated using your controller hub or remotely on the AC Infinity app (paired with compatible controllers), where you will have access to automation programming and climate data.

You can also connect your favorite grow light and outlet device to integrate them into the UIS platform using our RJ11/12 adapter and control plug module.

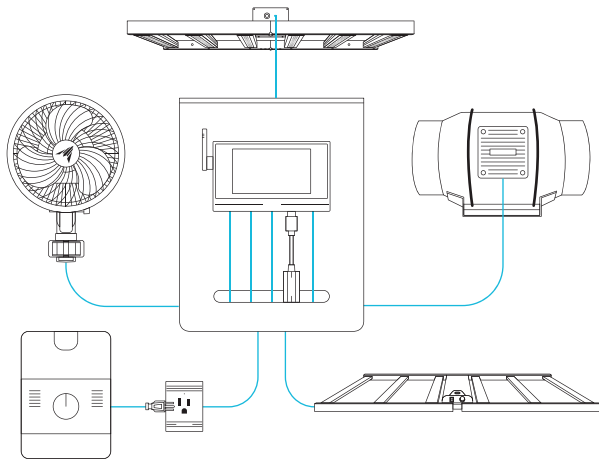

**Grow devices will be sold separately and may still be in development at the time of your purchase of this product.**

# COMPATIBILITY

## UIS™ PLATFORM

### MOLEX ADAPTER\*

Use a Molex adapter to plug inline fans with 4-pin Molex connectors into this controller. Plug your fan's Molex connector into the adapter. Then plug the adapter into the controller.

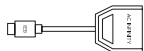

UIS M - 4PIN F  
ADAPTER

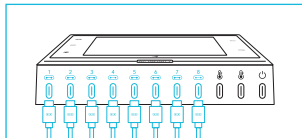

### EXTENSION CABLE

Use male-to-male UIS extension cords to connect devices with female UIS ports at an extended range from your controller. Included with UIS-compatible devices.

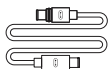

UIS M - M  
CORD

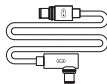

UIS M - M  
CLIP FAN CORD

### EXPANSION SPLITTER\*

The expansion splitter will allow you to connect 4 devices to a single port and can support additional splitters to create up to 3 tiers of expansion ports. Intended for exclusive use with AC Infinity controllers with UIS ports.

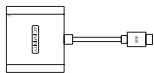

UIS M - F  
4 PORT SPLITTER

\*Not included

# COMPATIBILITY

## CONTROLLER AI+

Older generation models that previously used DC motors now contain EC motors in updated builds. Whereas fans that use DC motors connect to its controller to receive power, fans that use EC motors connect to electrical sockets to receive power. Neither the fan nor the controller is backwards compatible with the same product of an older generation that use DC motors and older controllers.

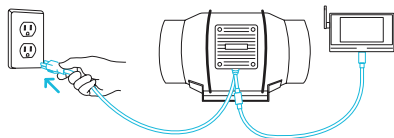

**EC Motor - Compatible**

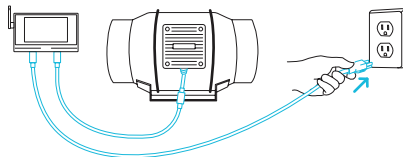

**AC or DC Motor - NOT Compatible**

# ADDING MORE FANS

The CONTROLLER AI+ is built with eight ports that enable you to power and simultaneously control multiple fans at the same time. Compatible with inline fans with EC motors only. See image below for a sample configuration.

## Multi-Fan Connection

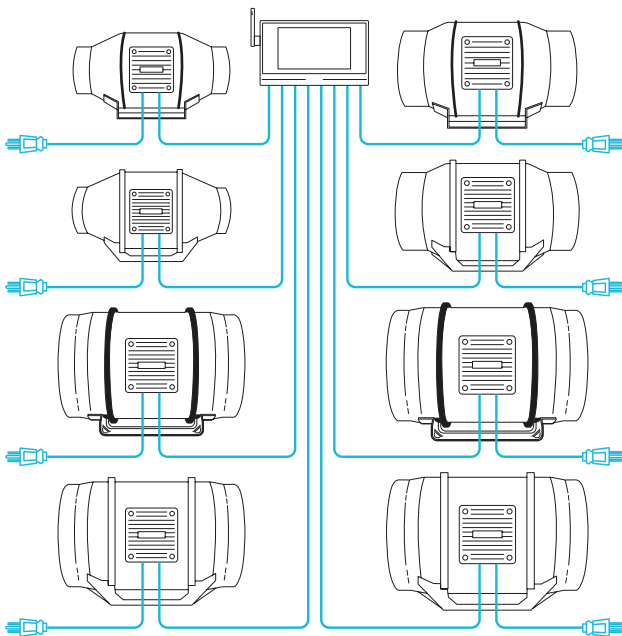

# ADDING MORE DEVICES

## EXTENDING THE CHAIN

Plug the male end of the splitter\* into your UIS controller. Connect a UIS device or power adapter to the first port of each tier to power your controller and the hub.

Ports 2-4 can connect to additional splitters or UIS devices. All devices plugged into this chain must be of the same type (ex. fans of any size) regardless of the length of the dongle chain.

This splitter is not compatible with UIS adapters such as the RJ11 Lighting Adapter.

\*Not included

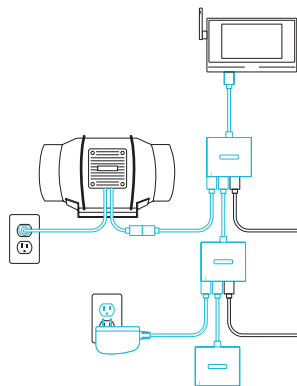



# ADDING MORE DEVICES

## DAISY-CHAINING

Each of the included controller's ports can support up to 20 devices using a daisy-chain adapter (not included). All devices must be from the same series but can be of differing sizes.

Plug the male end of the daisy-chain adapter into your device.

Connect your UIS controller to the daisy-chain adapter's INPUT port using a M-M connector cord. Using an extension cord, attach the daisy-chain adapter's OUTPUT port to another adapter's INPUT port. You can also link the OUTPUT port to another UIS device to end the chain.

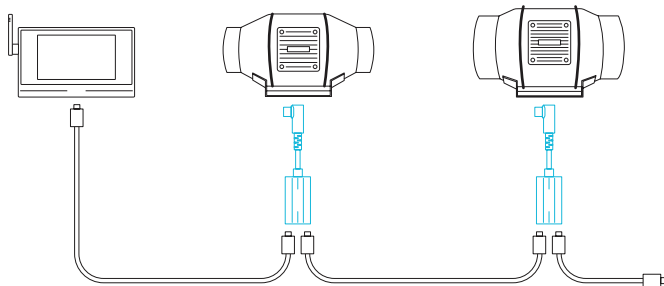
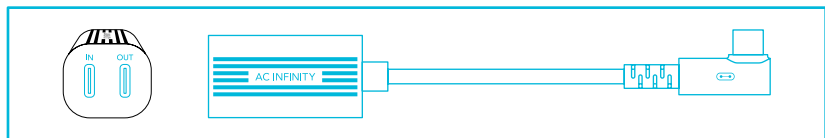

# CLEANING

## INLINE FAN

### STEP 1

Remove the motor box from the mounting flange. Refer to steps 1 and 2 on page 11 to learn how to remove the motor box.

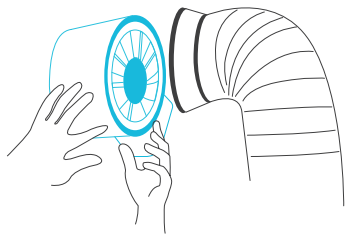

---

### STEP 2

Use a damp cloth to clear the impeller and fan blades of any dust and debris. Remove the wind circle in between the motor box and input flange.



# CLEANING

## INLINE FAN

### STEP 3

Clear the stator blades of any dust and debris on the opposite end. Clean the area inside the output and exhaust flanges.

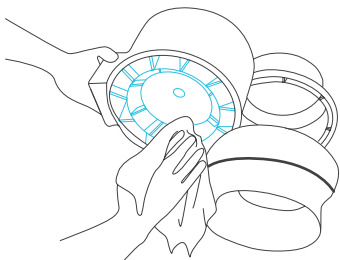

---

### STEP 4

Secure the motor box onto the mounting flanges. Refer to steps 7-9 on pages 14-15 to learn how to secure the motor box.

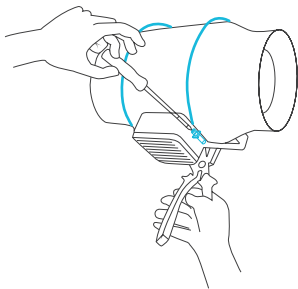

# CLEANING

## CARBON FILTER

### REVERSING THE FLANGES

To extend the filter's lifespan and utilize its entire carbon bed, rotate the flanges from either end.

Remove the screws from the flanges to release them from the filter. Replace the flanges on the other ends and screw them back into place.

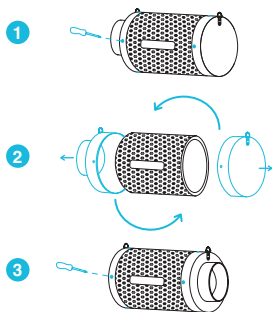

---

### WASHING THE PREFILTER

Wash the reusable cloth as needed to clear it of any dust and build-up. This will further extend the lifespan of the filter.

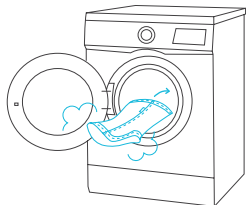

# PROGRAMMING

## S-SERIES

### FAN SPEED ADJUSTING

The controller features a single button that controls the fan speed from 0-10. Pressing the speed button increases the fan speed in one unit increments. Pressing the button at the 10 setting will set the fan speed back to 0.

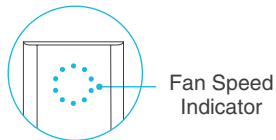
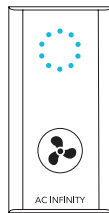

---

### POWERING ON/OFF

Holding the speed button for 4 seconds will turn the fan OFF. Pressing it again from OFF will turn the fan ON at its last speed setting.

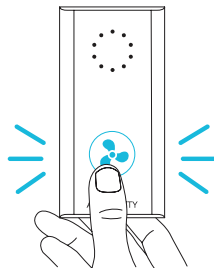

# PROGRAMMING

## T-SERIES



### CONTROLLER AI+

For in-depth programming instructions, refer to the included CONTROLLER AI+ Quick Start Guide. The following resources are also available for further assistance.



### WEBPAGE OVERVIEW

Read through this instruction guide to easily explore all that your controller has to offer.

# DOWNLOAD THE APP

## THE AC INFINITY APP

The AC Infinity app enables you to connect with the next generation of our intelligent controllers, giving you access to advance programs and environmental data.

1

Download the AC Infinity app from the App Store or Play Store by searching “AC Infinity”.



2

Open the AC Infinity app and follow the instructions on page 48-54 to pair your controller with the app.



---

## QUICK TIP FOR EASY ACCESS

Open the smart phone camera and scan the QR code below to download the AC Infinity app. Please visit our website at [www.acinfinity.com](http://www.acinfinity.com) for more information on the AC Infinity app.



Please note: The AC Infinity App's appearance and features are subject to change, and please refer to our website/ QR for the latest instructions.

# ADD A DEVICE

## BLUETOOTH

### SETUP AND PAIRING

Power your device on before pairing your controller with the app. Logging in or creating an account beforehand will expedite the pairing process. Have your Wi-Fi network's name and password ready.

1

Tap on the "+" tab to add your smart device.

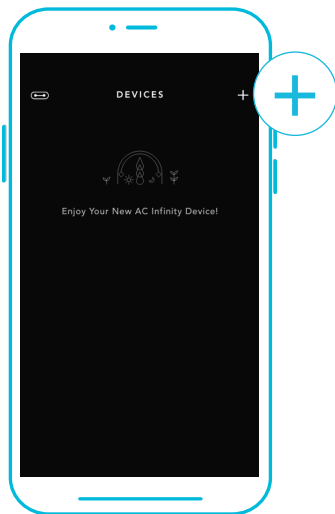

2

Select "Smart Controllers".

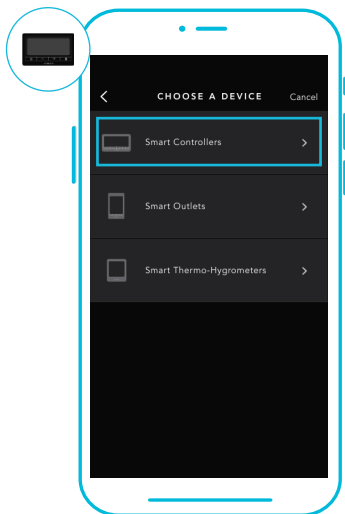

Wi-Fi and location permissions must be enabled on your mobile device before starting the pairing process.



# ADD A DEVICE

## BLUETOOTH

3

Select CONTROLLER AI+.

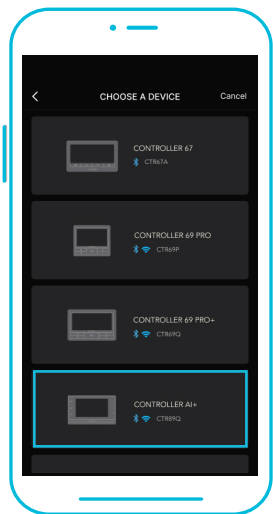

4

Hold the port button for 5 seconds to activate Bluetooth. Wait for the Bluetooth icon to start flashing on your controller's screen to release the button.



# ADD A DEVICE

## BLUETOOTH

5

Connect using Bluetooth. To connect using Wi-Fi, skip to step 8.

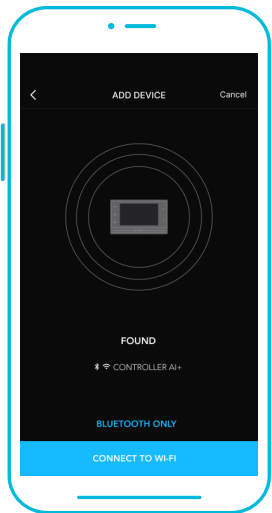

6

Connecting with Bluetooth will disable Wi-Fi functionality. Go to the app settings page to re-enable and connect using Wi-Fi.

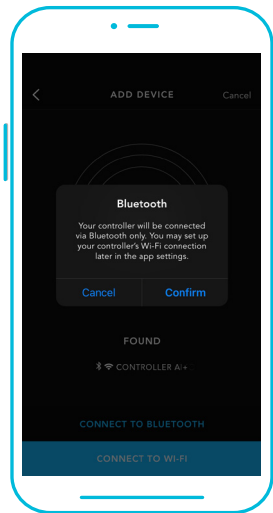

When pairing the app around multiple controllers, move your mobile device closer to your desired controller.

# ADD A DEVICE

## BLUETOOTH

7

Tap the DONE button to complete the pairing process.

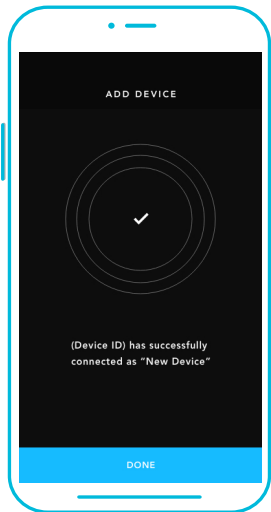

# ADD A DEVICE

## WI-FI

8

Repeat steps 1-5. Log in or create an account to continue.

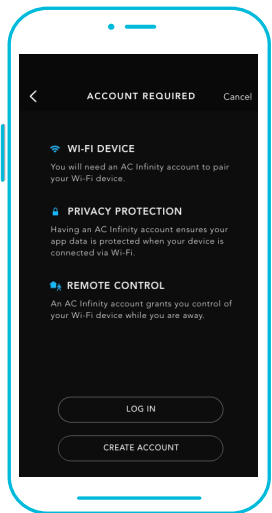

9

Enter your Wi-Fi network's password. You may also connect to an alternate 2.4 GHz router\*.

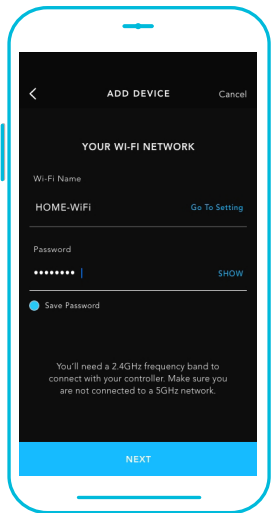

When pairing the app around multiple controllers, move your mobile device closer to your desired controller.

# ADD A DEVICE

## WI-FI

10

Follow these tips if the pairing process is unsuccessful.

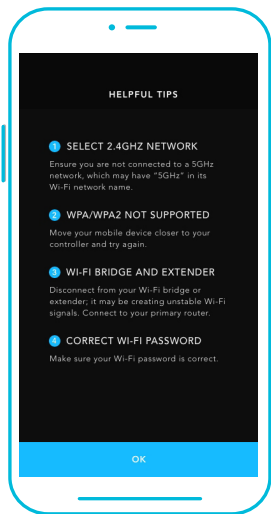

11

Tap the DONE button to complete the pairing process.

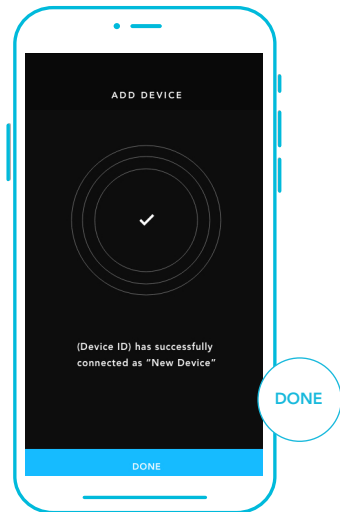

\*This controller is only compatible with 2.4 GHz frequency band routers. When connecting using Wi-Fi, make sure your mobile device is not connected to a 5 GHz frequency band network.

# ADD A DEVICE

## WI-FI

12

Your controller will appear in your smart device with a unique ID.

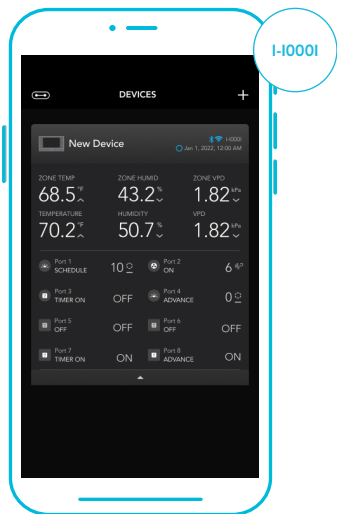

# CONTROLLER AI+ FAQ

**Q:** What devices are compatible with CONTROLLER AI+?

**A:** All AC Infinity devices that contain a UIS connector are compatible. If your AC Infinity device has a 4-pin Molex connector and an EC motor, it may still be compatible with the use of a UIS adapter to convert its connector to fit with the controller.

---

**Q:** Where is the best place to position the sensor probe?

**A:** Place the sensor probe as close as possible to the hottest or most humid spot in your space.

---

**Q:** Do I need to remove the plastic cap from the probe?

**A:** Yes. You will need to remove the plastic cap so the probe can accurately read climate conditions.

---

**Q:** Can I connect different-sized fans to the same controller?

**A:** Please refer to pages 38-41 for details on adding more fan units.

---

**Q:** Will I be able to use this controller with my own devices?

**A:** CONTROLLER AI+ is only compatible with devices in the UIS platform. Look for our logo on your AC Infinity device's packaging for UIS compatibility.

---

**Q:** Does the controller retain its settings after power is shut off?

**A:** Yes. If the controller's power is cut off and is powered on afterward, your settings will remain.

# CONTROLLER AI+ FAQ

**Q:** My controller isn't pairing with the app. How do I fix this?

**A:** If the pairing process isn't successful, press any button to return to the normal screen. Then hold the port button for 5 seconds to try again. When starting the pairing process around multiple Wi-Fi controllers, move your smart device closer to the controller you wish to connect the app with.

---

**Q:** Why does the app ask me for location permissions?

**A:** The app requires location permissions to find the relative position of your smart controller and communicate with existing Bluetooth devices already paired with the app. All Android devices prior to system version 12.0 will require location permissions to be turned on for the Bluetooth scan to be successful.

---

**Q:** Why do the port's level digits on the screen occasionally flash when I unplug a device?

**A:** The controller may have received electronic interference during the disconnection. To fix this, completely cut off power from the controller by unplugging all connected devices. Then plug them back into their previous ports and resume normal use.

---



## PROGRAMMING FAQs

If you have any programming questions, visit our website for in-depth explanations and instructions.



# CLOUDLINE FAQ

**Q:** Can I mount this inline duct fan vertically?

**A:** Yes. The CLOUDLINE fan can be mounted in any orientation, including vertically.

---

**Q:** Will I be able to hardwire this fan to my own controller or thermostat?

**A:** We do not recommend hardwiring or splicing our fan's power wires. Such modifications may compromise electrical safety and will void this product's warranty.

---

**Q:** Do I need to use a power converter if I'm outside the US?

**A:** This product's voltage range is 100-240V AC. You may need a simple travel adapter to plug it into a foreign socket, or a power converter if your country uses a different voltage.

---

**Q:** I'm not getting enough airflow even after setting the fan speed to 10. What can I do?

**A:** Bends in ducting will reduce your fan's CFM performance. To retain airflow, you may straighten the ducting and eliminate as many bends as possible.

---

**Q:** Should I use this inline duct fan as an intake or an exhaust fan?

**A:** The CLOUDLINE fan is primarily used as an exhaust fan, but can be used as an intake fan as well. You may use this fan as an intake fan if you need fresh air into your space.

---

**Q:** I'm hanging my fan upside down in my grow tent, can I rotate its motor box plate?

**A:** Yes. Use a screwdriver to unscrew the motor cap. Rotate it to your desired orientation and reapply the screws.

# AC INFINITY PRODUCTS

## Advance Grow Tents

The CLOUDLAB series is a line of grow tents designed to create ideal growing conditions and facilitate indoor plant cultivation year-round. Features 2000D thick oxford canvas lined with inner diamond patterned mylar that maximizes grow light luminosity, and a reinforced frame with 150 lb. weight capacity. Includes a mounting plate to install your AC Infinity controller onto.

---

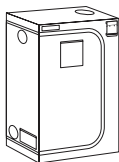

## Inline Duct Fans

The CLOUDLINE series is a line of duct fans designed to quietly ventilate AV rooms and closets, as well as various DIY air circulation and exhaust projects. Features a thermal controller with intelligent programming that will automatically adjust duct fan speeds in response to changing temperatures.

---

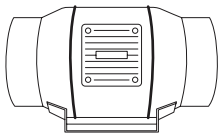

## Grow Lights

An indoor LED grow lamp designed to simulate outdoor daytime lighting to improve and accelerate your plant's photosynthesis. Using the latest Samsung LM301H diodes, this LED grow system efficiently produces full-spectrum lighting usable during all stages of the grow cycle.

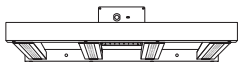

Discover the latest innovations in environmental controls at [acinfinity.com](http://acinfinity.com)

# WARRANTY

This warranty program is our commitment to you, the product sold by AC Infinity will be free from defects in manufacturing for a period of two years from the date of purchase. If a product is found to have a defect in material or workmanship, we will take the appropriate actions defined in this warranty to resolve any issues.

The warranty program applies to any order, purchase, receipt, or use of any products sold by AC Infinity or our authorized dealerships. The program covers products that have become defective, malfunctioned, or expressively if the product becomes unusable. The warranty program goes into effect on the date of purchase. The program will expire two years from the date of purchase. If your product becomes defective during that period, AC Infinity will replace your product with a new one or issue you a full refund.

The warranty program does not cover abuse or misuse. This includes physical damage, submersion of the product in water, incorrect installation such as wrong voltage input, and misuse for any reason other than intended purposes. AC Infinity is not responsible for consequential loss or incidental damages of any nature caused by the product. We will not warrant damage from normal wear such as scratches and dings.

Contact our dealers department at [dealers@acinfinity.com](mailto:dealers@acinfinity.com) or (626) 838-4656 for more information about our dealers and distributors program. Contact our customer service department at [support@acinfinity.com](mailto:support@acinfinity.com) or 626-923-6399 for product and warranty assistance. Our business hours are Monday through Friday, 9:00 am to 5:00 pm PST.



**If you have any issues with this product, contact us and we'll happily resolve your problem or issue a full refund!**

**COPYRIGHT © 2024 AC INFINITY INC. ALL RIGHTS RESERVED**

No part of the materials including graphics or logos available in this booklet may be copied, photocopied, reproduced, translated or reduced to any electronic medium or machine readable form, in whole or in part, without specific permission from AC Infinity Inc.







[www.acinfinity.com](http://www.acinfinity.com)